

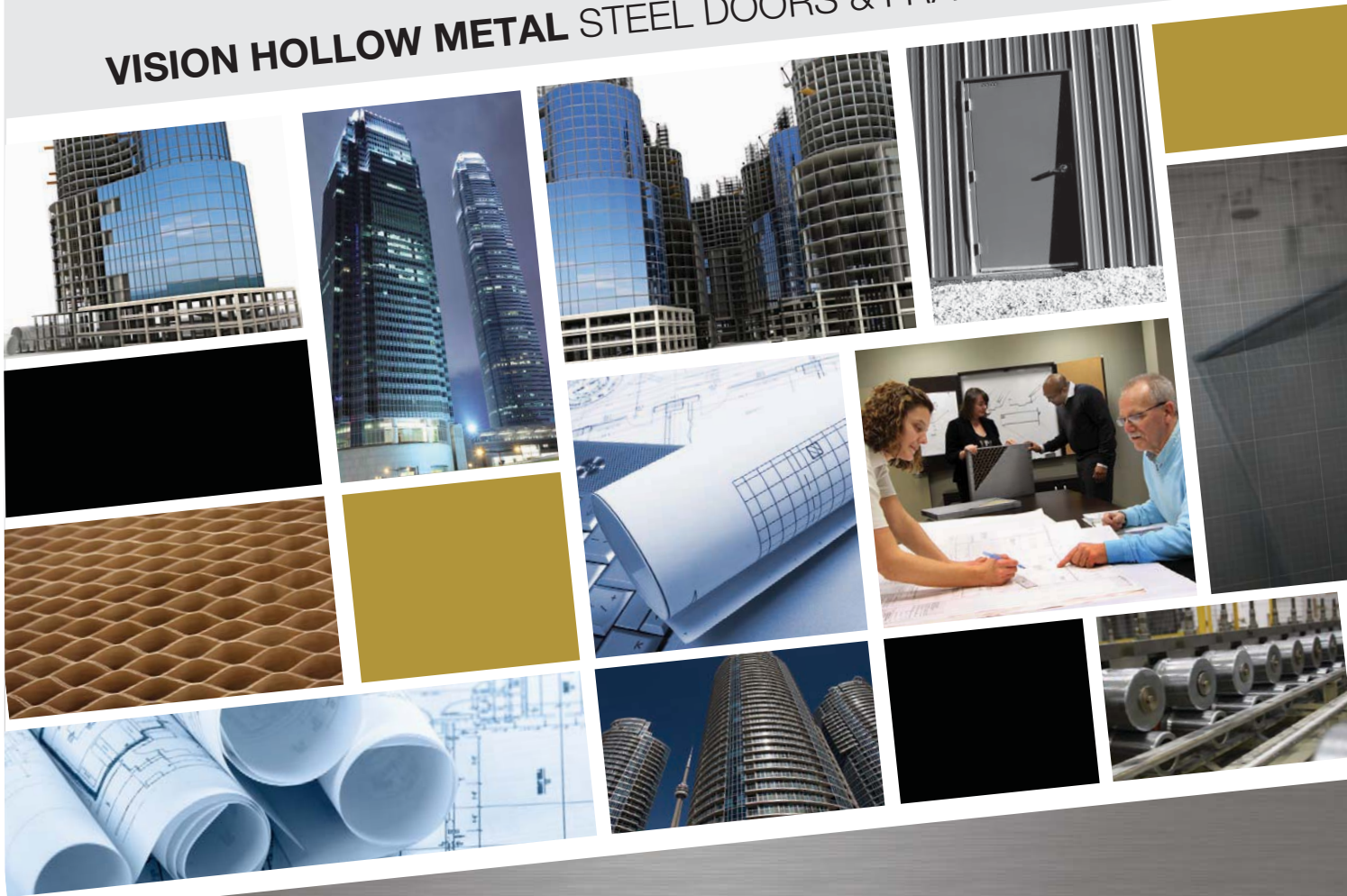

# VISION HOLLOW METAL STEEL DOORS & FRAMES



FROM A  
**PLAN**  
TO A  
**VISION**

# TABLE OF CONTENTS

## COMPANY PROFILE

The VisionP hilosophy	Page 2
The Galvanneal Steel Standard of Excellence	Page 2
Standards&Comp liance	Page 2
Affiliations	Page 2

## VISION SERIES DOORS

StandardV isionL ites	Page 4
LS Series Door	Page 5
CW Series Door	Page 6
EP Series Door (Embossed 6-Panel)	Page 7
EP Series Door (Embossed 2 Panel)	Page 8

## VISION SERIES FRAMES

DW Series Frame	Page 10
ADJ Series Frame	Page 11
FF Series Frame	Page 12
MAS Series Frame	Page 13
WD Series Frame	Page 14

# COMPANY PROFILE

## THE VISION PHILOSOPHY

Vision Hollow Metal Limited is a leading edge manufacturer of steel doors and frames for commercial, industrial, and institutional applications. Founded in 2008, Vision Hollow Metal entered the market with a clear goal, to be the best. The formula for success was simple.

- **A management team with over 130 combined years of product knowledge and industry experience**
- **The best and most efficient equipment designed to provide both standard and engineered products**
- **A commitment to manufacturing high quality products at competitive prices**
- **Flexible service, quick lead times, and a warehouse full of ready to ship commodity products**
- **The drive to develop strong business relationships that will generate long term customer loyalty**

These key factors represent the foundation of Vision's core business model and have become the cornerstone of the company's business philosophy.

## THE GALVANNEAL STEEL STANDARD OF EXCELLENCE

What is Galvanneal Steel? Galvanneal Steel is a continuously hot dipped galvanized product with the zinc coating completely converted to a zinc-iron alloy. It is this Galvanneal coating that provides corrosion resistance similar to what you see in the automotive industry. At Vision Hollow Metal steel doors and frames are manufactured using Galvanneal Steel as standard.

Why use Galvanneal Steel instead of cold rolled steel? Galvanneal Steel compared to cold rolled steel is a far superior zinc-iron coated product. In manufacturing of steel doors and frames there are two distinct advantages for using Galvanneal Steel.

**Superior Corrosion Performance:** Galvanneal Steel has improved coating control over the entire product, thus the coating composition is consistent and uniform in appearance. The very fine matte finish acts like a primer and is naturally an excellent shield against rust.

**Paintability and Long Reliable Service Life:** A tightly adherent paint film on Galvanneal Steel lasts longer than it would on non-galvanized steel because the zinc helps prevent rusting and blistering. Paint and zinc together will help to extend the useful life of the product as compared to unpainted galvanized steel or painted non-galvanized steel products.

## STANDARDS & COMPLIANCE

Vision Hollow Metal products conform to the following standards:

### North America

UL 10(c) (2001), UBC 7-2 (1997) Part 1, ASTM E2074-04, Standard Method of Fire Tests of Door Assemblies (Positive Pressure), CAN/ULC S104-M80(R) 1985), UL 10(b) (2008), UBC 7-2 1994 NFPA 252 (2008), Method of Fire Tests of Door Assemblies, under negative furnace pressure.

### Hurricane

Vision Hollow Metal products have been tested to meet the stringent hurricane requirements of Miami-Dade County, Florida.

## AFFILIATIONS



# VISION SERIES DOORS



# STANDARD VISION LITES

VL1

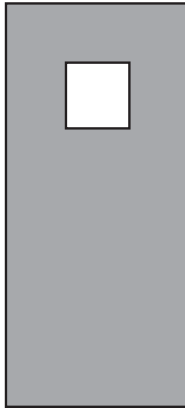

VL2

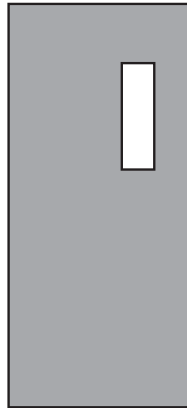

VL3

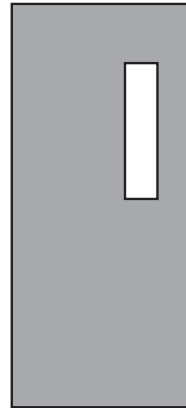

VL4

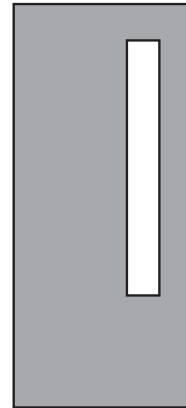

VL6

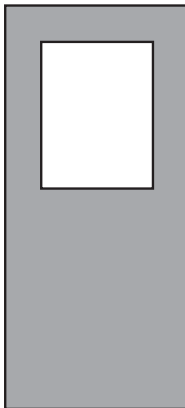

VL7

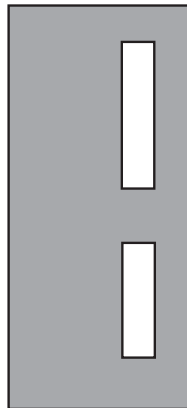

VL8

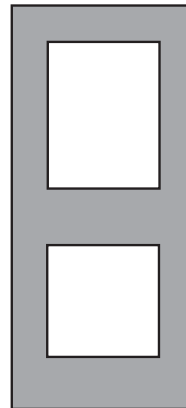

VL9

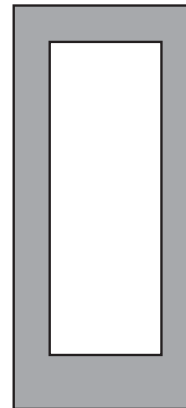

VL10

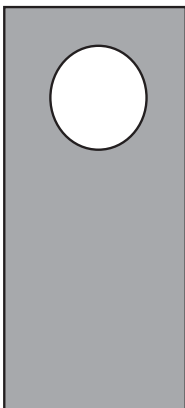

# LS SERIES DOOR

## Lock Seam (1 3/4" Thick)

LS Series Doors are designed for standard and heavy duty applications and are made to provide years of maintenance free performance. These doors are perfect for a wide array of applications in commercial, industrial, and institutional buildings. LS Series Doors are available in 20 GA, 18 GA, and 16 GA and can be fire rated up to 3 hours.

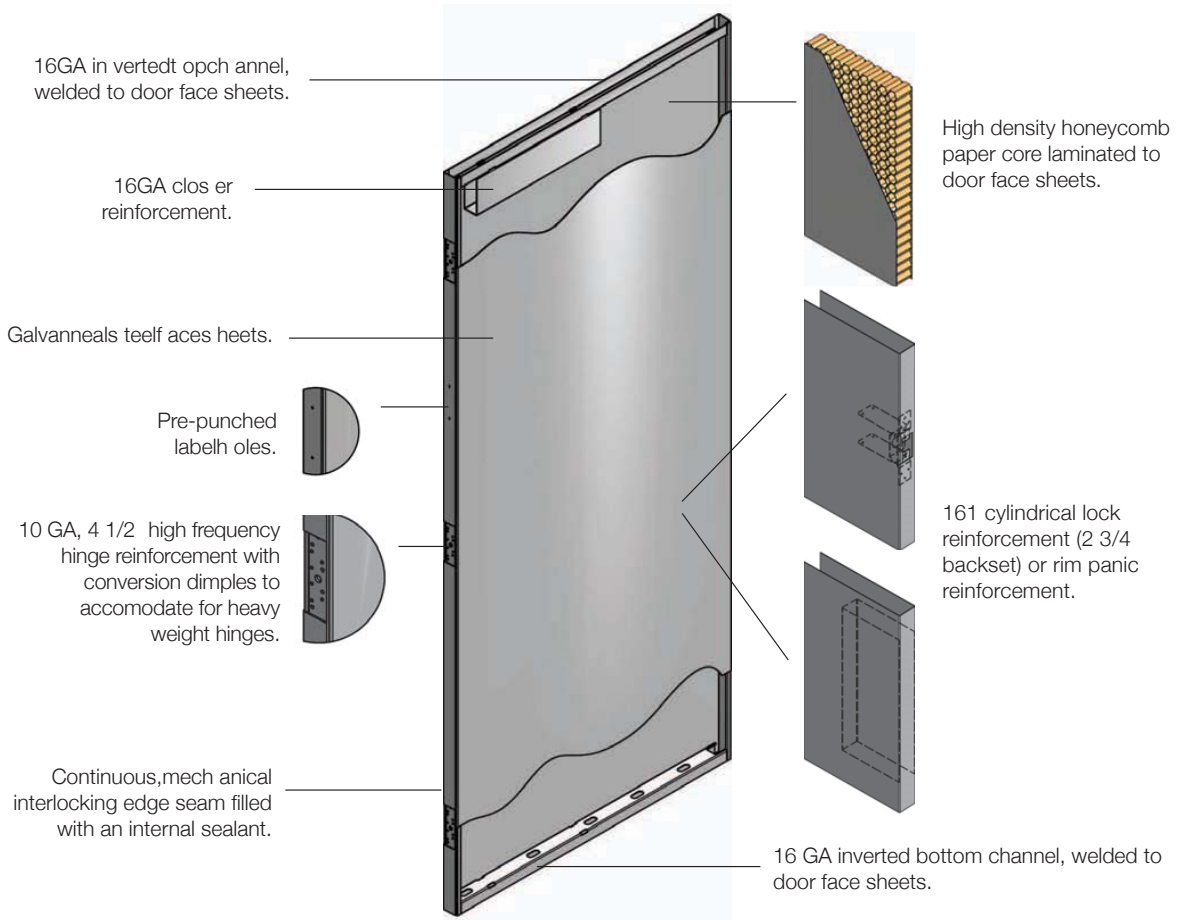

### Lock Options

- (Standard) 161 Cylindrical Lock
- (Standard) Rim Panic Reinforced
- (Optional) Mortise Lock #86

Additional Custom Door Options Are Available

# CW SERIES DOOR

CW Series Door is constructed with the purpose of providing the highest strength and durability. With steel stiffeners welded to the door faces and continuously welded, CW Series Doors are the perfect solution for high security or high traffic areas such as schools and detention centres. CW Series Doors are available in 16 GA and 14 GA and can be fire rated up to 3 hours.

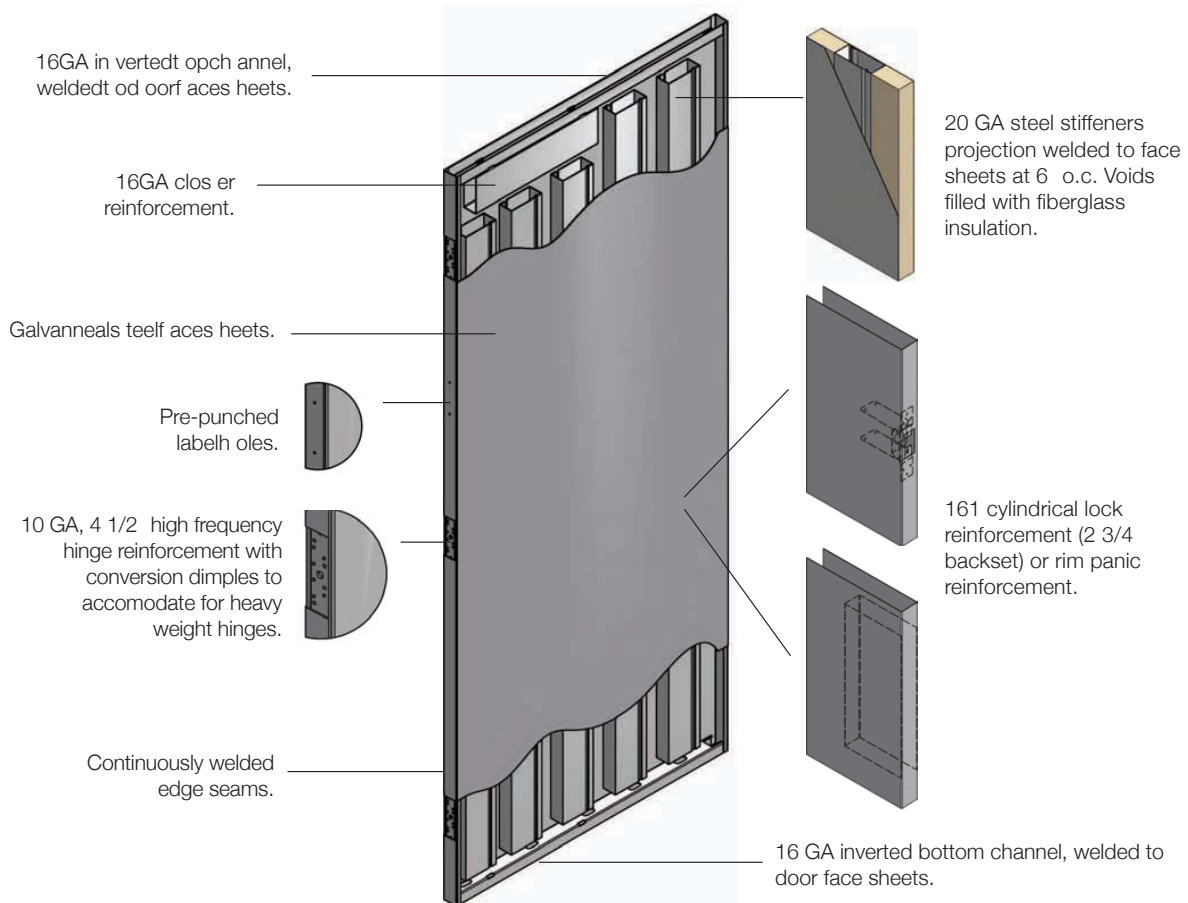

## Lock Options

- (Standard) 161 Cylindrical Lock
- (Standard) Rim Panic Reinforced
- (Optional) Mortise Lock #86

Additional Custom Door Options Are Available

CW SERIES DOOR

# EP SERIES DOOR

## Embossed 6-Panel (1 3/4" Thick)

The EP Series Door provides the highest level of strength and durability with beauty and elegance. Ideal for commercial offices or high end residential applications such as apartment buildings and condos. EP Series Doors are available in 20 GA and 18 GA and can be fire rated up to 3 hours.

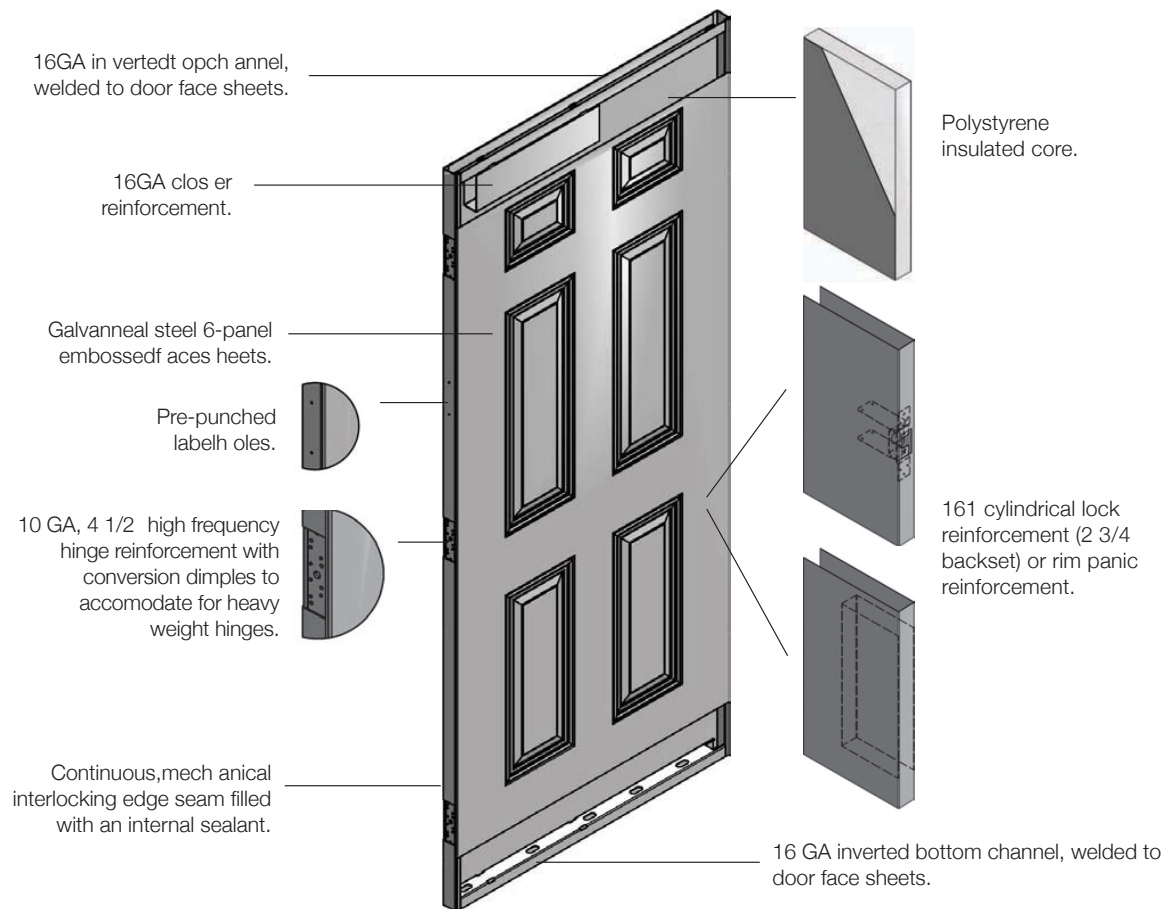

EP SERIES DOOR

### Lock Options

- (Standard) 161 Cylindrical Lock
- (Standard) Rim Panic Reinforced
- (Optional) Mortise Lock #86

Additional Custom Door Options Are Available



# EP SERIES DOOR

## Embossed 2-Panel (1 3/4" Thick)

The EP Series Door provides the ideal combination of strength and durability with beauty and elegance. Ideal for commercial offices or high end residential applications such as apartment buildings and condos. EP Series Doors are available in 20 GA and 18 GA and can be fire rated up to 3 hours.

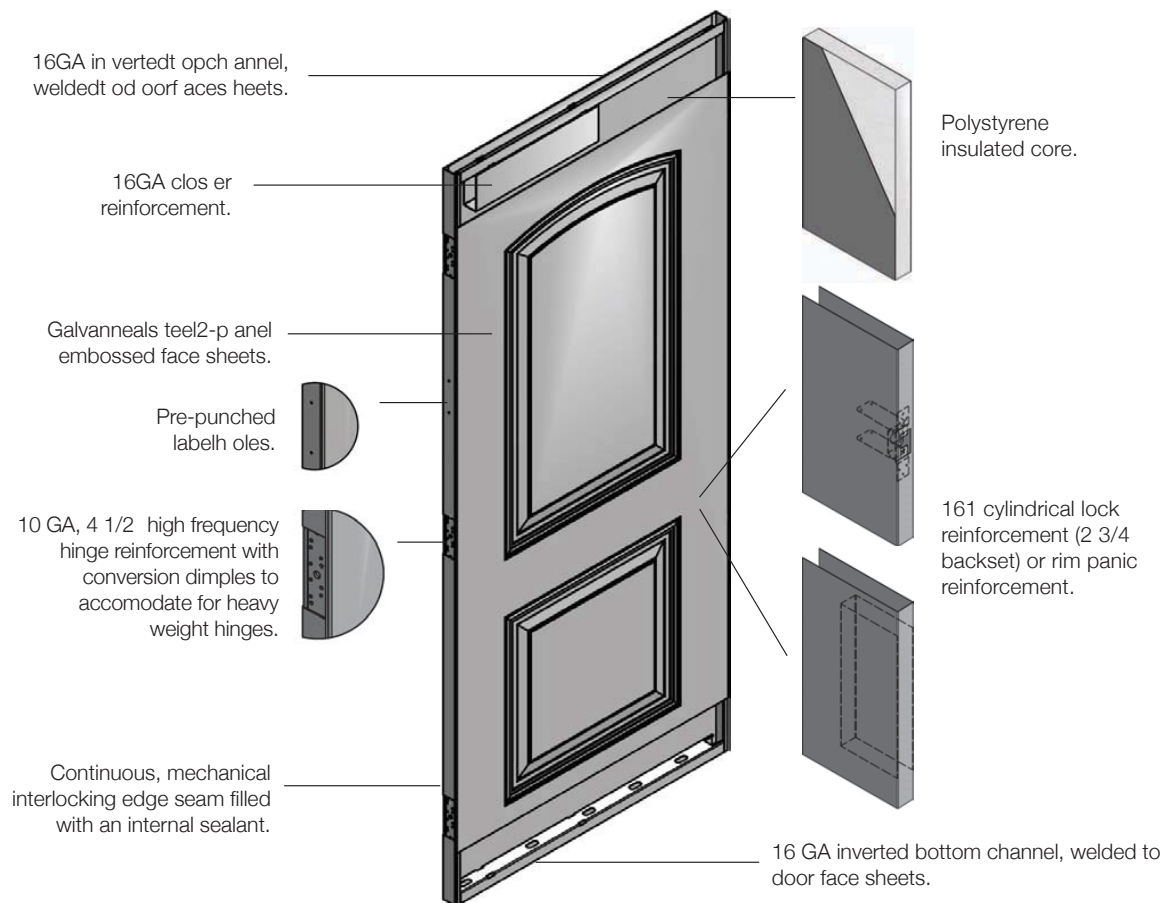

### Lock Options

- (Standard) 161 Cylindrical Lock
- (Standard) Rim Panic Reinforced
- (Optional) Mortise Lock #86

Additional Custom Door Options Are Available

EP SERIES DOOR

# VISION SERIES FRAMES



# DW SERIES FRAME

## Drywall

DW Series Frames are designed for effortless installation into drywall applications. These frames are fabricated complete with centre and bottom strap anchors, compression anchors, and double returns and are available in 18 GA or 16 GA. DW Series Frames can be made to accommodate a wide variety of sizes and jamb depths and can be fire rated up to 1 1/2 hours.

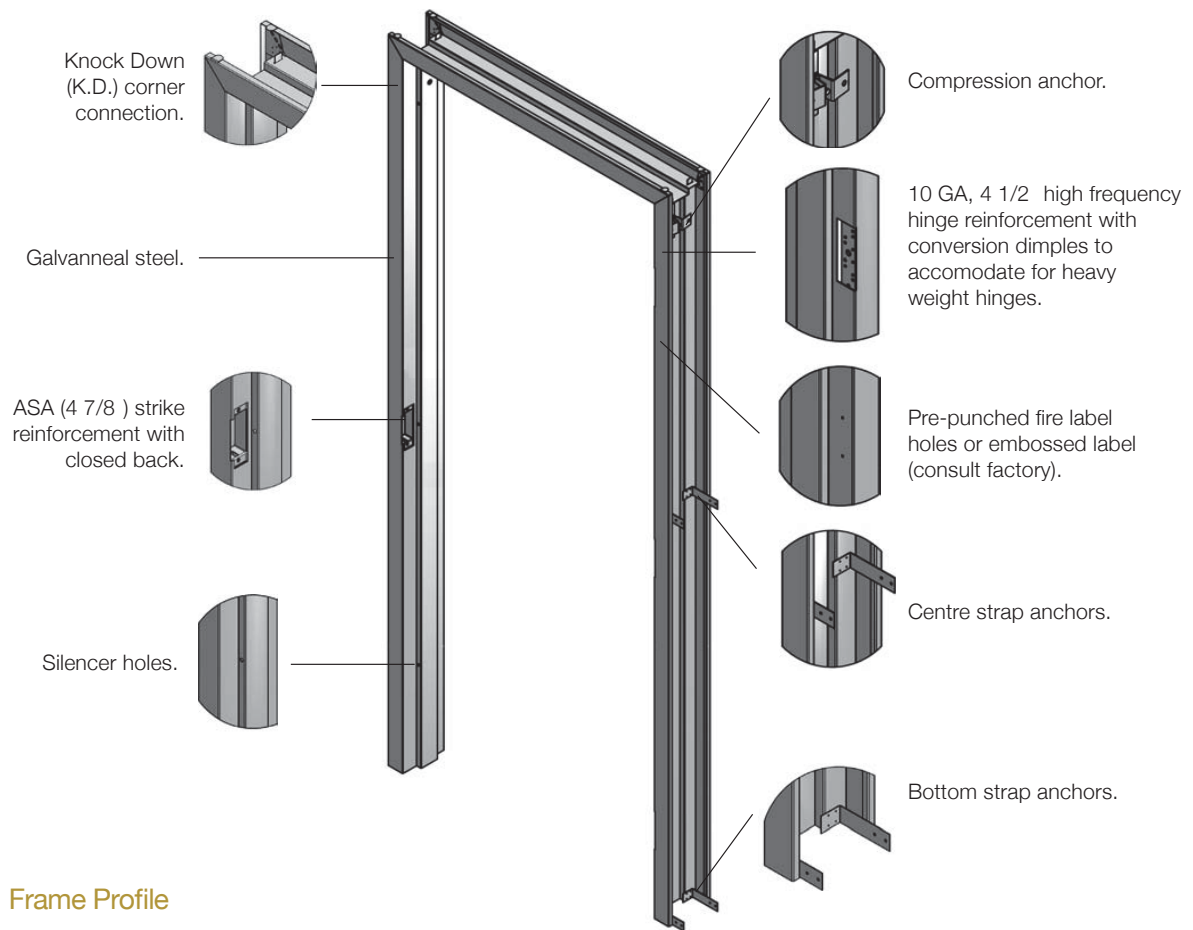

### Frame Profile

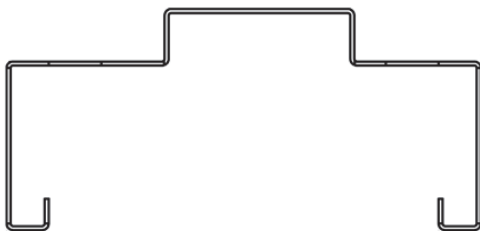

Additional Custom Frame Options Are Available

DW SERIES FRAME

# ADJ SERIES FRAME

## Adjustable

ADJ Series Frames provide the ultimate versatility for use in drywall applications or masonry butt applications as this frame can be adjusted to fit a wide range of wall thicknesses. Offered in two sizes, the ADJ-S will accommodate wall thicknesses ranging from 4 1/2" to 7 3/4" while the ADJ-L will accommodate wall thicknesses ranging from 7 1/2" to 12 1/4". ADJ Series Frames are available in 16 GA and can be fire rated up to 1 1/2 hours.

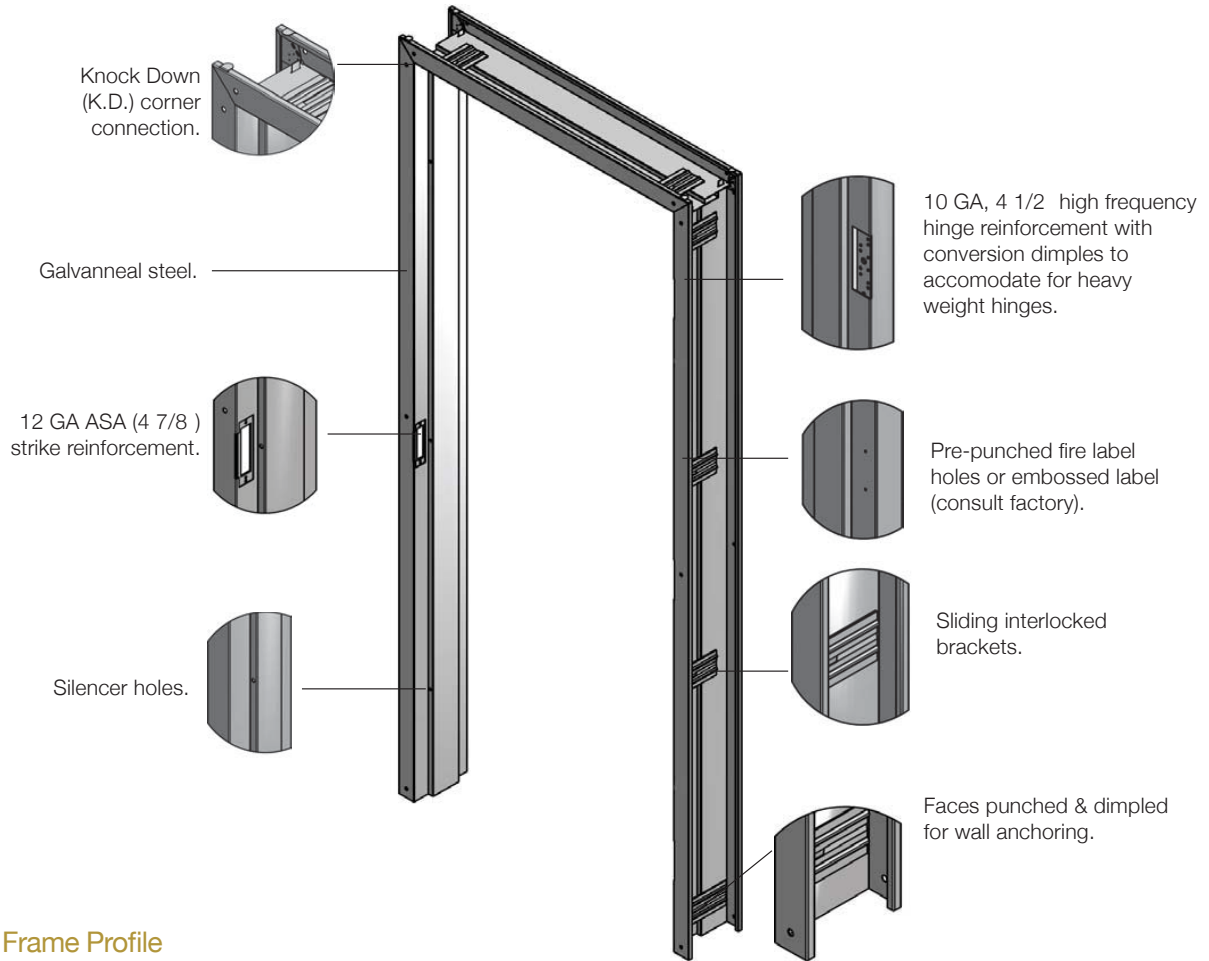

### Frame Profile

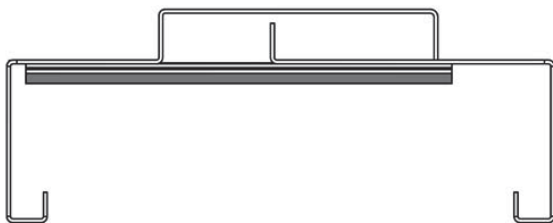

Additional Custom Frame Options Are Available

ADJ SERIES FRAME

11

Tel: 905-851-1211

Fax: 905-851-1261

Web: [www.visionhollowmetal.com](http://www.visionhollowmetal.com)

# FF SERIES FRAME

## FlushFit

FF Series Frames are the perfect solution for entrances that require the strength of a steel frame with the look of a wood frame. FF Series Frames are manufactured without returns and are designed to sit flush on the wall, allowing for the installation of wood casing over top. These frames are best suited for condominiums, hotels, or offices where durability and design take precedence. FF Series Frames are available in 18 GA and can be fire rated up to 3/4 hours.

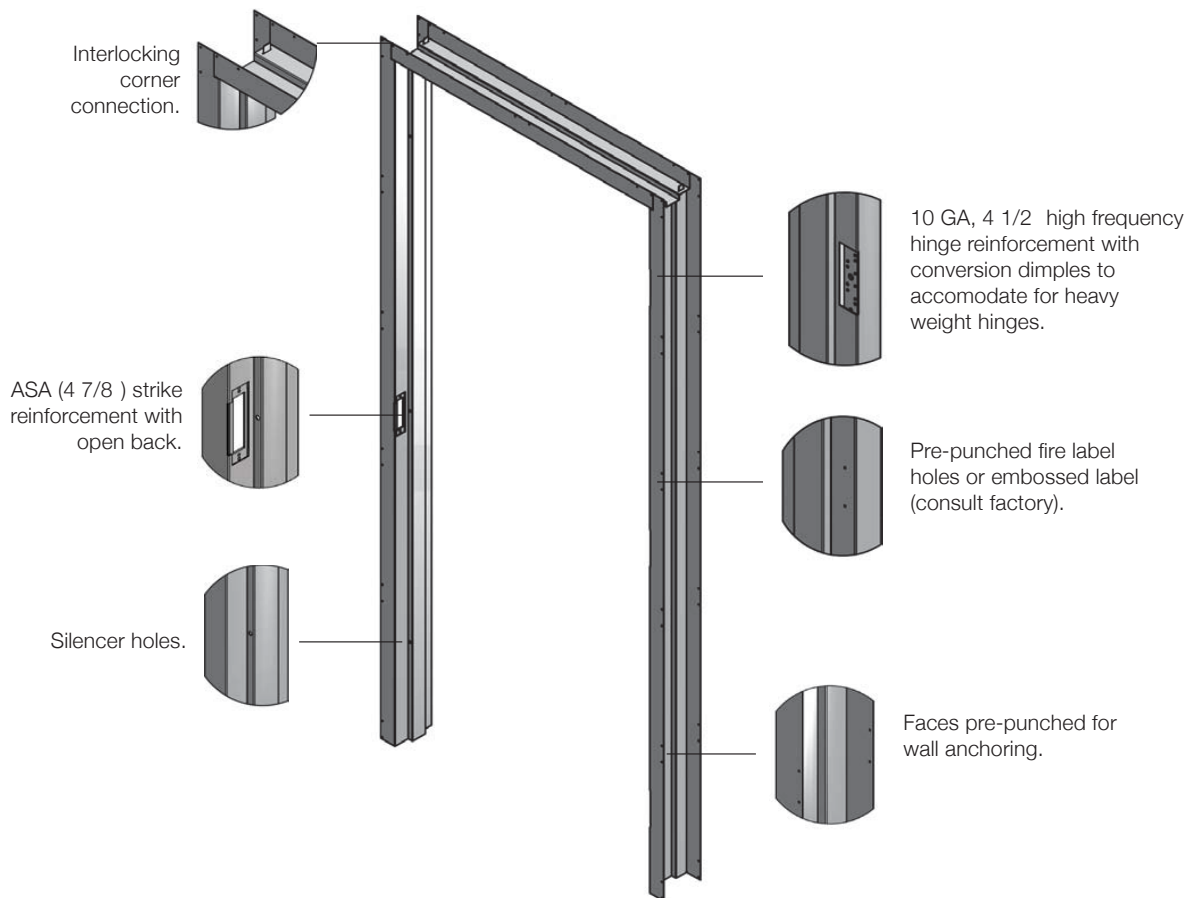

### Frame Profile

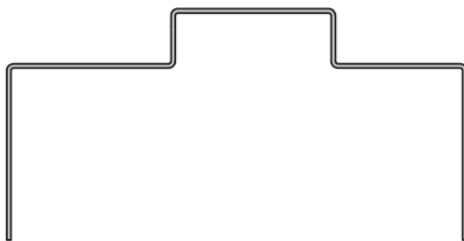

Additional Custom Frame Options Are Available

FF SERIES FRAME

# MAS SERIES FRAME

## Masonry

MAS Series Frames are made to suit masonry applications in commercial, industrial, or institutional settings. These frames come complete with floor anchors and are available in 18 GA or 16 GA. MAS Series Frames can be made to accommodate a wide variety of sizes and jamb depths and can be fire rated up to 3 hours.

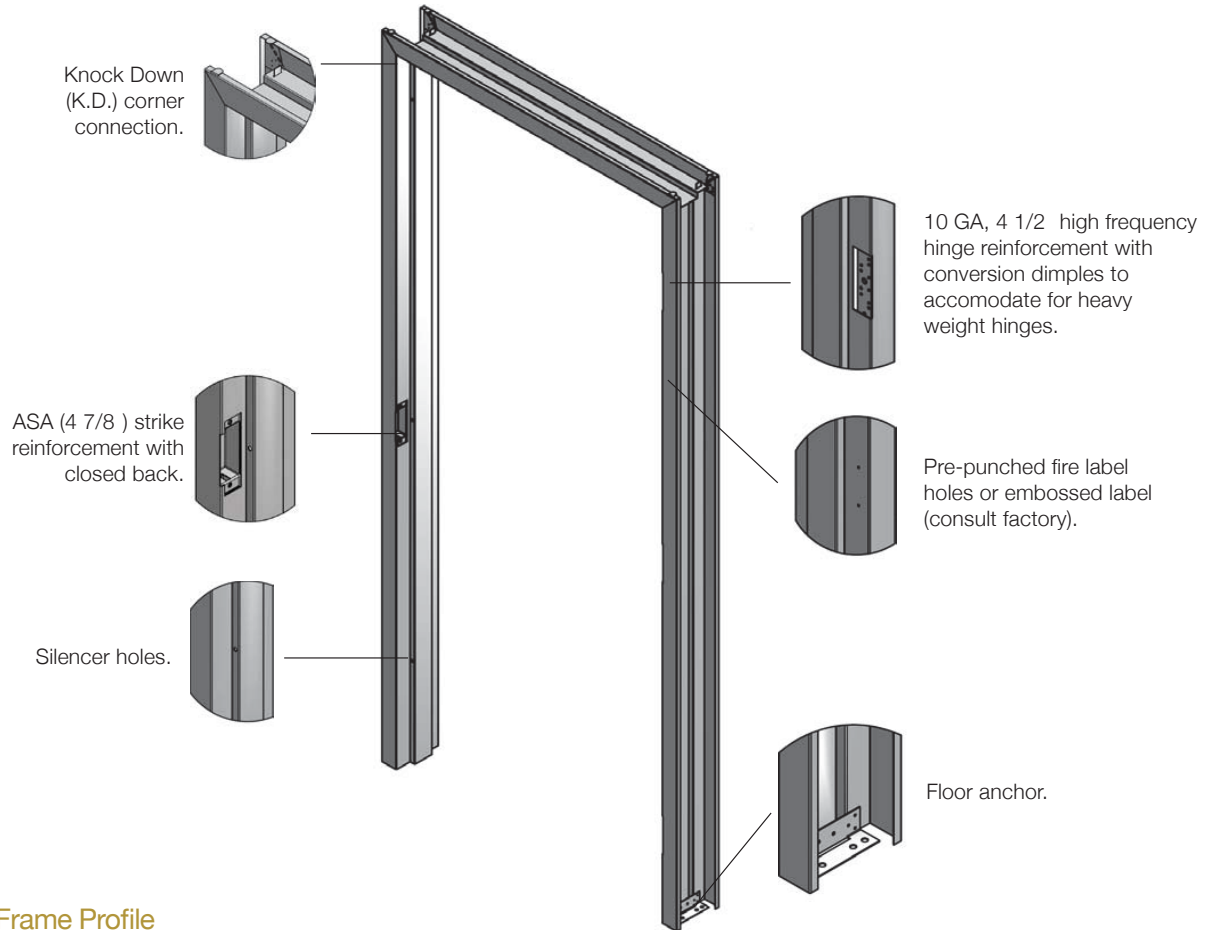

## Frame Profile

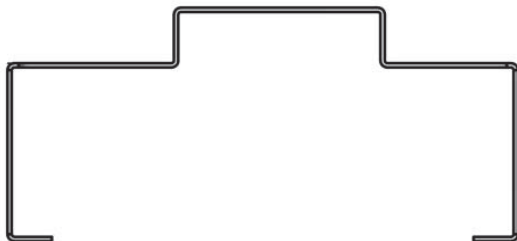

Additional Custom Frame Options Are Available

MAS SERIES FRAME

# WD SERIES FRAME

## Welded

WD Series Frames are Vision's welded frame program where frames are prepped and welded at the factory and shipped direct to site or to the distributor for immediate shipment. WD Series Frames are available in 18 GA or 16 GA and can be made as standard 3-sided frames or custom engineered windows, transoms, or screens/sidelights. WD Series Frames can also be fire rated up to 3/4 hours.

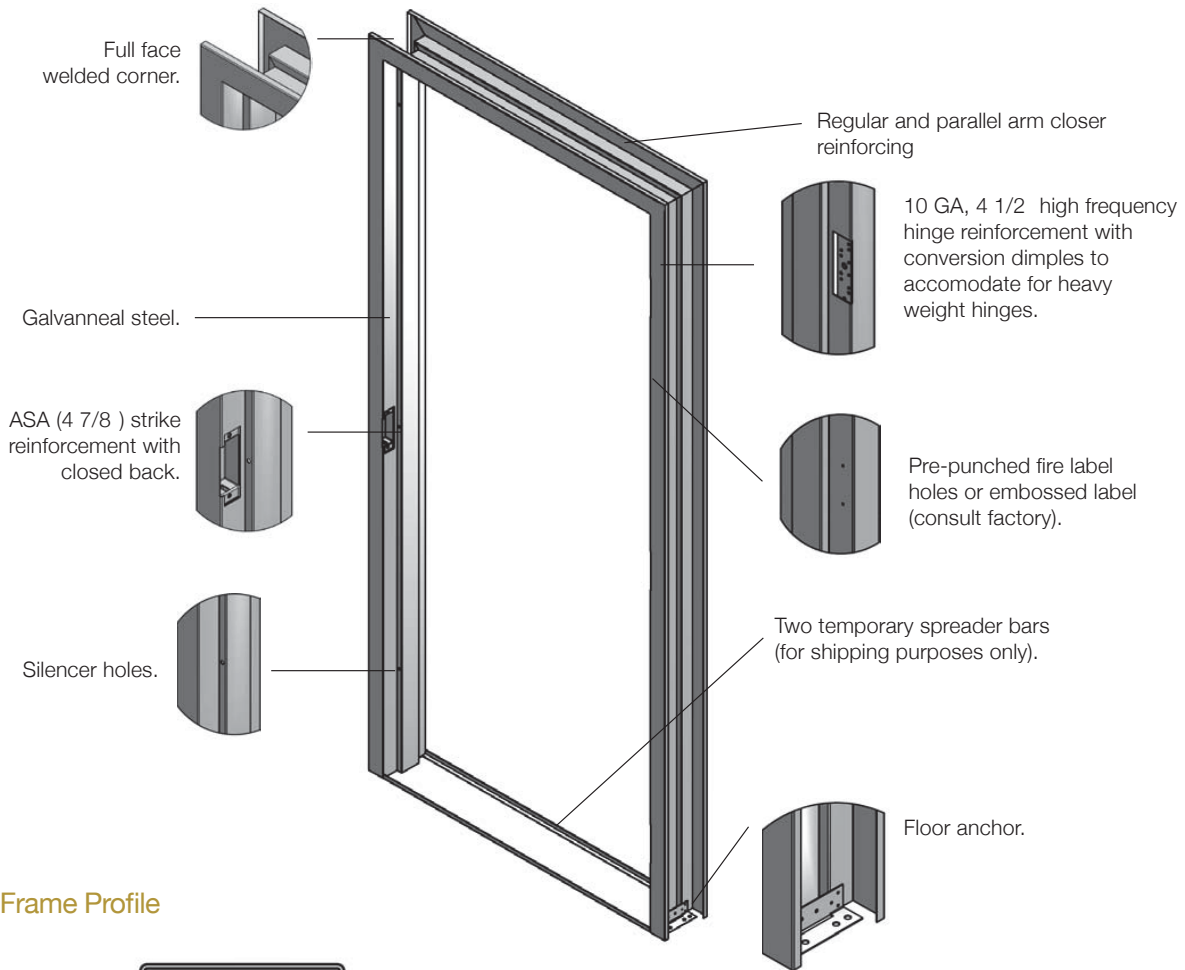

Additional Custom Frame Options Are Available

WD SERIES FRAME



Vision Group of Companies is a customer focused, technology driven group of companies focused on building products. Our foundation is a century old manufacturing sector and is recognized as a leader in the building products industry. Vision products span a wide range of applications including columns, decking, fencing, railings, patio doors, steel doors, roofing, custom profiles, and transportation.

To learn more about bringing your vision to life, please visit us at

[www.visiongroupofcompanies.com](http://www.visiongroupofcompanies.com)

**VISION HOLLOW METAL LIMITED**

400 Zennway Blvd., Unit #1 Woodbridge, ON L4H 0S7

Tel: 905-851-1211 Fax: 905-851-1261 Toll Free: 1-877-984-8465

Web: [www.visionhollowmetal.com](http://www.visionhollowmetal.com)

Email: [info@visionhollowmetal.com](mailto:info@visionhollowmetal.com)